

LINK BRM 10-73

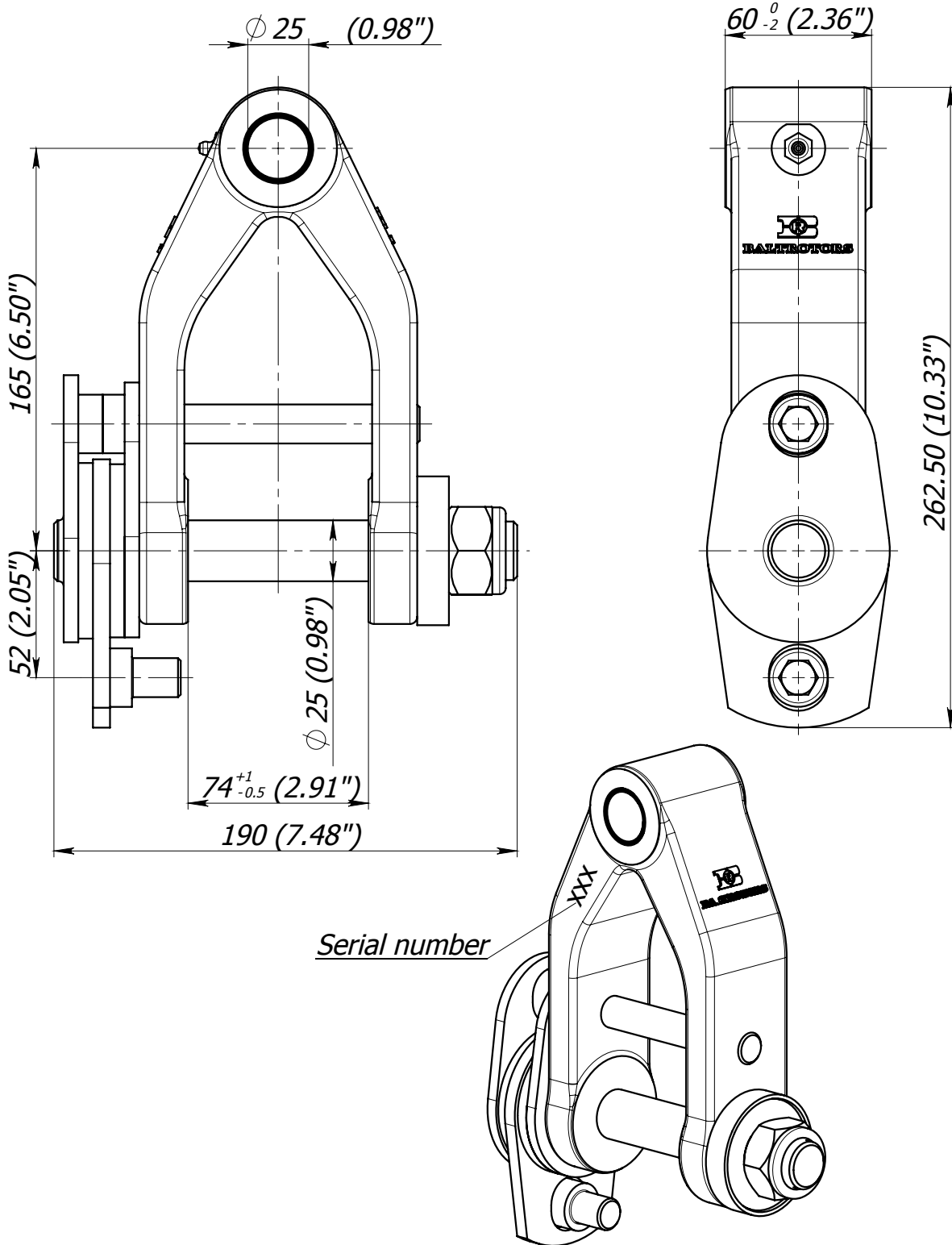

- * Pin locking nut is tightened with a torque of 60 - 160 Nm (45 - 120 lb ft) dependent on desired brake power.
- * Weight - 4.73 kg (10.42 lb)
- * Fill grease Starplex EP 2, through lubricating nipple (pos. 12), until it will appear to the external surfaces. Greasing must be repeated after every 8 working hours of the link.

